

Benefits:

- ◆ Low torque minimizes system torque budget
- ◆ Compact design to fit in the most demanding space.
- ◆ Smooth running
- ◆ Low electrical noise
- ◆ Quick shipment per your urgent requirement
- ◆ 360° continuous rotation
- ◆ High bandwidth transfer capability

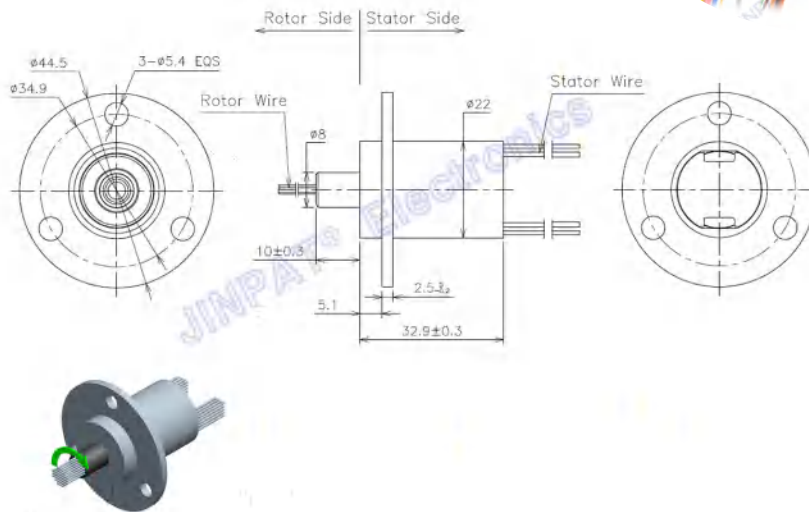

Electronic & Electric			Mechanical	
Circuits	Total	18CKT	Working Speed	0~300rpm
	Detail	18x2A	Contact Material	Gold to Gold
Rating Voltage		240V AC/DC	Housing Material	Engineering plastics
Dielectric Strength		$\geq 500\text{VAC}@50\text{Hz(P)}$ $\geq 100\text{VAC}@50\text{Hz(S)}$	Lead Wire Length	Stator: $250 \pm 5\text{mm}$ Rotor: $250 \pm 5\text{mm}$
Insulation Resistance		$\geq 100\text{M}\Omega@500\text{VDC(P)}$ $\geq 10\text{M}\Omega@100\text{VDC(S)}$	Dynamic Resistance Fluctuation Value	$\leq 35\text{m}\Omega$
Environment			Remarks	
Working Temperature		$-20^{\circ}\text{C} \sim +60^{\circ}\text{C}$	Application	/
Working Humidity		$\leq 60\%\text{RH}$	Other	/
IP		IP40	Note: "P" stands for power, "S" stands for signal.	