

Benefits:

- ◆ Low torque minimizes system torque budget
- ◆ Compact design to fit in the most demanding space.
- ◆ Smooth running
- ◆ Low electrical noise
- ◆ Quick shipment per your urgent requirement
- ◆ 360° continuous rotation
- ◆ High bandwidth transfer capability

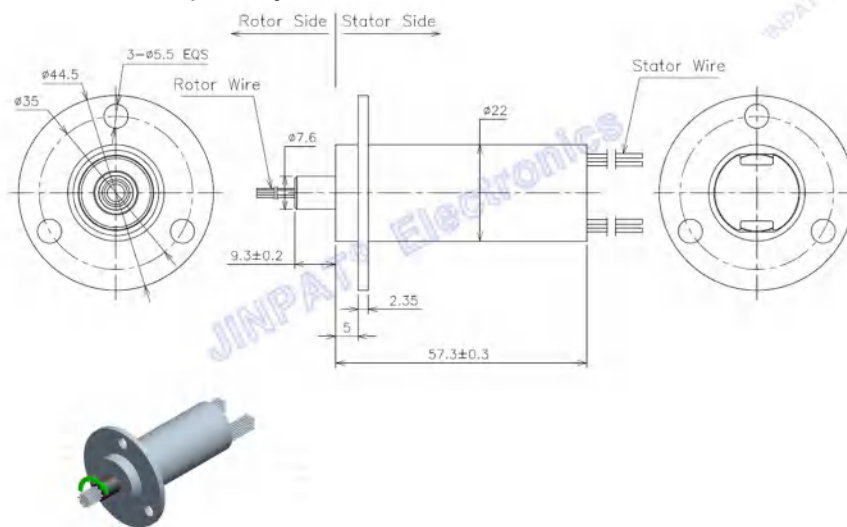

Electronic & Electric		Mechanical		
Circuits	Total	36CKT	Working Speed	0~300rpm
	Detail	36x2A	Contact Material	Gold to Gold
Rating Voltage		240V AC/DC	Housing Material	Engineering plastics
Dielectric Strength		≥500VAC@50Hz(P) ≥100VAC@50Hz(S)	Lead Wire Length	Stator:250±5mm Rotor:250±5mm
Insulation Resistance		≥100MΩ@500VDC(P) ≥10MΩ@100VDC(S)	Dynamic Resistance Fluctuation Value	≤35mΩ
Environment		Remarks		
Working Temperature	-20°C~+60°C	Application	/	
Working Humidity	≤60%RH	Other	/	
IP	IP40	Note: "P" stands for power, "S" stands for signal.		